

Fixed Attenuator

DC to 3 GHz
6dB
80 Watt
N Type



Features

- High Power
- High attenuation accuracy
- Small VSWR
- Low PIM

Model No. Description

FATXXXXXX

X- power handling:80W.

X- connector type: SMA, N type or SMB connector.

XX- attenuation: **dB.

XX- frequency range, 03: DC to 3GHz

06: DC to 6GHz

18: DC to 18GHz.

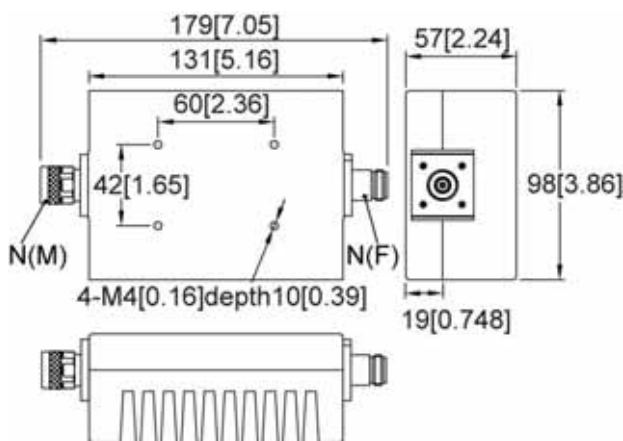

Notes:

1. all dimensions shown in mm & inch
2. Dimensions Tolerance $\pm 2\%$
3. Dimensions and specifications refer to connector type N unless otherwise specified.
4. Custom designs available for other special attenuation value & accuracy

Specifications

Frequency Range	DC to 3 GHz
Attenuation	6 dB
Attenuation Accuracy	± 0.6 dB over DC - 3 GHz
Nominal Impedance	50 Ohm
Average Power	80 Watt
Operating Temperature	-55 to +125

FREQ. RANGE (GHz)	Typical VSWR(:1)	Maximum VSWR(:1)
DC to 1	1.10	
1 to 2	1.20	
2 to 3	1.25	
DC to 3		1.30

Material & Plating

Parts	Material	Plating(Micro-inch)
Body & Nut	Aluminum	Black Anodize
Contact (female & male)	QSn6.5-0.1	Gold 30
Insulator	Teflon	

AVERAGE POWER: 80W average to 25°C ambient temperature, derated linearly to 8W @ 125°C.

PEAK POWER: 10KW (5 μ s pulse width with 0.8% duty cycle)

CONNECTOR TYPE: N, N male to N female unidirectional type(Input port is only on the male side, and output port is only on the female side)