

# Data Sheet

## FAC4300

50Ω Up to 2W DC to 32GHz



### Features

- Small Size (2×2mm DFN package)
- Super Wide bandwidth,DC-32GHz
- Excellent VSWR,1.3:1 typ.
- High Power Handling,2W
- Operating Temperature:-40°C to 85°C
- High ESD level\*mls3

### Typical Applications

- 5G
- Test and Measurement
- Radar
- Communication
- Defense

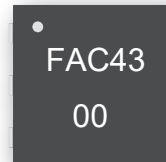
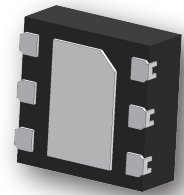

### General Description

FAC4300 is absorptive fixed attenuator fabricated using highly reliable GaAs MMIC process. The model operates from DC to 32GHz.It achieves outstanding attenuation accuracy and flatness while maintains excellent VSWR throughout the entire band. The model can also handle input power up to 2W,which makes this model an ideal choice for a wide range of applications.

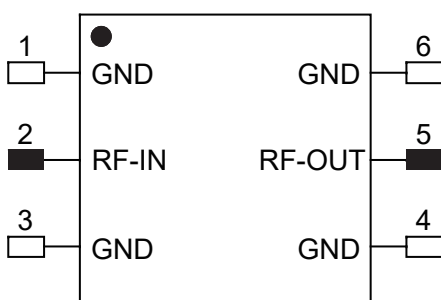

TOP VIEW

Notes:

- 1.This part has passed through 100% RF test.

### Yantel Corporation

Add: No.308-322, 3F, Building 1, Juchuang Jingu Innovation Park, Wenyuan Road 35, Xili Street, Nanshan, Shenzhen, China  
Tel: 86-755-8355-1886 Fax: 86-755-8355-2533

# Data Sheet

## FAC4300

50Ω Up to 2W DC to 32GHz



### Key Features

Feature	Advantages
Wideband operation, From DC to 32 GHz	Supports a wide array of applications including 5G, wireless infrastructure, microwave communications, satellite, defense and aerospace, medical broadband and optic applications
Small Size and simple to use (2 mm x 2 mm)	As a single chip solution, the FAC43 series occupies less board space than a lumped element approach, minimizes component count and ensures repeatable performance over wide frequency range.
Wide range of nominal attenuation values (0, 1, 2, 3, 4, 5, 6, 7, 8, 9, 10, 12, 15, 20 & 30)	Small increment offering enables circuit designer to change attenuation values without motherboard redesign making the FAC43 series ideal for select at test application.
MCLP™ Package	Low Inductance, repeatable transitions, excellent thermal path make the FAC43 series an ideal solution as an alternative to “do it yourself” lumped element-based approach.

\* IPD - Integrated Passive Device.

### Product Marking

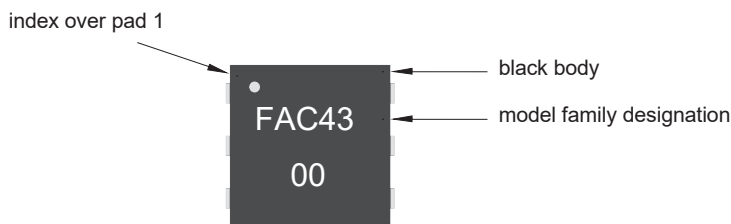

Marking may contain other features or characters for internal lot control

### ESD Rating

Human Body Model (HBM): Class 2(Pass 2000V) per ANSI/ESD STM 5.1-2001

### Characterization Test Circuit

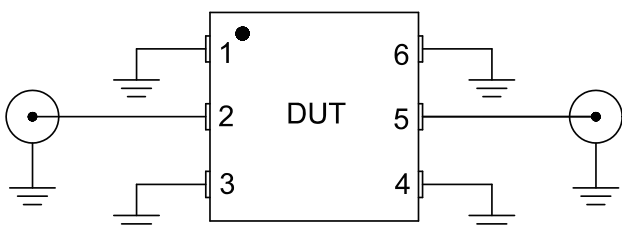

Block diagram fo Test Circuit used for characterization.

### Yantel Corporation

Add: No.308-322, 3F, Building 1, Juchuang Jingu Innovation Park, Wenyuan Road 35, Xili Street, Nanshan, Shenzhen, China  
Tel: 86-755-8355-1886 Fax: 86-755-8355-2533

Rev A1.2

For detailed performance specs & shopping online see Yantel web site : [www.yantel-corp.com](http://www.yantel-corp.com)

# Data Sheet

## FAC4300

50Ω Up to 2W DC to 32GHz



### Electrical Specifications at 25° C

Paramter	Freq.Range (GHz)	Min.	Typ.	Max.
Frequency Range		DC	-	32
Attenuation (dB)	DC-32	0	0.2	1
Return Loss (dB)	DC-32	8.2	18	-

### Test Curve

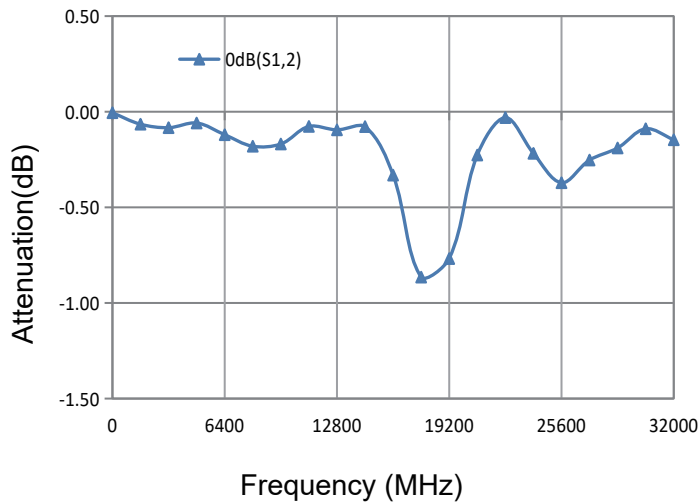

Frequency MHZ	S12 (dB)	Return Loss(dB)	
		S11	S22
0	-0.01	-46.38	-61.72
1600	-0.07	-29.77	-32.12
3200	-0.08	-29.59	-28.45
4800	-0.06	-31.80	-26.98
6400	-0.12	-23.12	-23.54
8000	-0.18	-16.61	-16.89
9600	-0.17	-15.34	-15.44
11200	-0.08	-19.32	-18.62
12800	-0.09	-26.73	-23.71
14400	-0.08	-20.92	-22.07
16000	-0.33	-11.13	-11.69
17600	-0.86	-8.33	-8.54
19200	-0.77	-10.19	-10.00
20800	-0.23	-15.78	-15.38
22400	-0.03	-18.62	-19.24
24000	-0.22	-15.76	-16.05
25600	-0.37	-13.88	-15.14
27200	-0.25	-17.09	-17.11
28800	-0.19	-19.40	-17.90
30400	-0.09	-18.61	-18.45
32000	-0.15	-17.15	-20.39

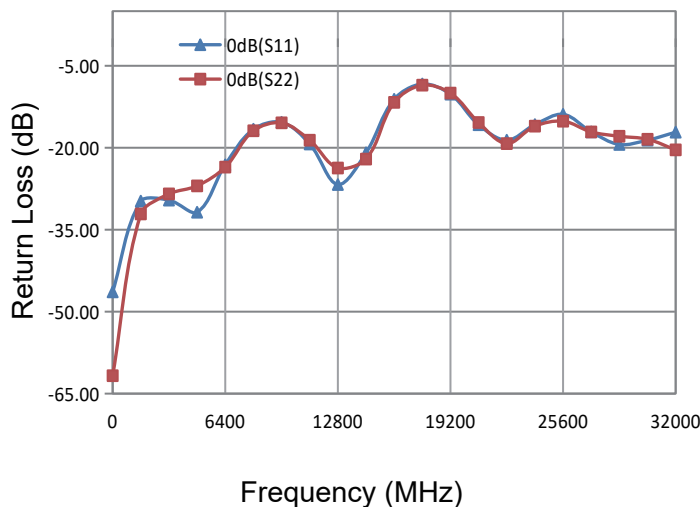

### Yantel Corporation

Add: No.308-322, 3F, Building 1, Juchuang Jingu Innovation Park, Wenyuan Road 35, Xili Street, Nanshan, Shenzhen, China  
 Tel: 86-755-8355-1886 Fax: 86-755-8355-2533

# Data Sheet

## FAC4300

50Ω Up to 2W DC to 32GHz



### Outline Drawing

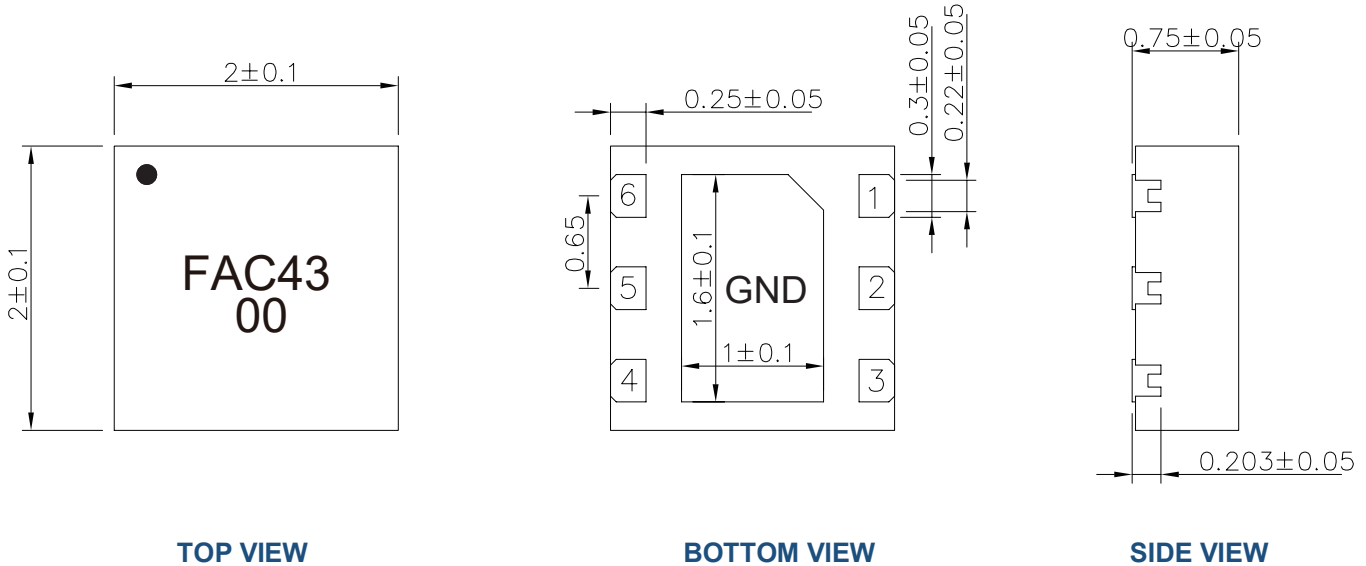

### Land Pattern

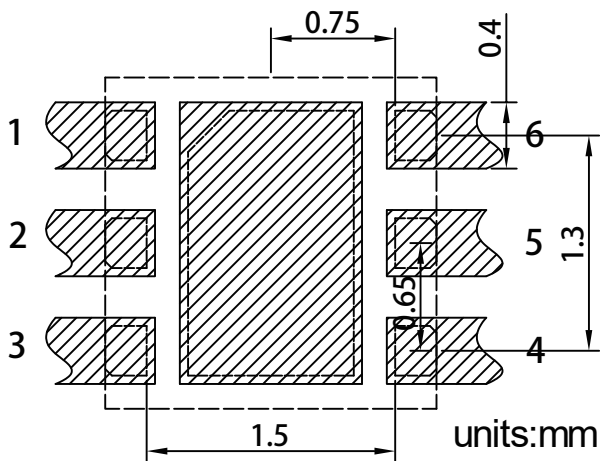

### Recommended Land Pattern Top View

Notes: All dimensions show in millimeters

### Pin Out

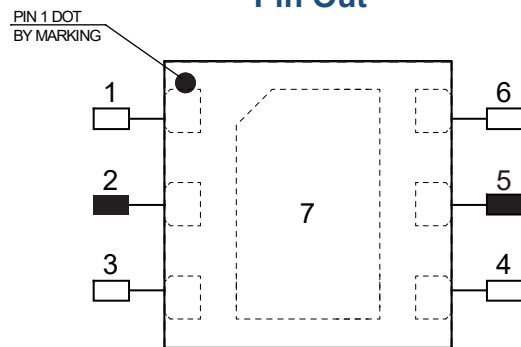

### TOP VIEW

Notes:

1. Require to add Capacitors of DC Blocker between Pins (with black color) and external circuit to prevent DC signal entry to guarantee parts normal work.
2. This part has passed through 100% RF test.

Pin #	Connection
1	GND
2	IN
3	GND
4	GND
5	OUT
6	GND
7	GND

### Yantel Corporation

Add: No.308-322, 3F, Building 1, Juchuang Jingu Innovation Park, Wenyuan Road 35, Xili Street, Nanshan, Shenzhen, China  
Tel: 86-755-8355-1886 Fax: 86-755-8355-2533

# Data Sheet FAC4300

50Ω Up to 2W DC to 32GHz



## Tape and Reel Drawing



ITEM	W	A0	B0	K0	K1	P	F	E	D0	P0	P2	t	7"
DIM(mm)	8.0	2.35	2.45	1.15		4.0	3.5	1.75	1.5	4.0	2.0	0.2	P/R
TOLE	+0.10 -0.10	+0.10 -0.10	+0.10 -0.10	+0.10 -0.10	+0.10 -0.10	+0.10 -0.10	+0.10 -0.10	+0.10 -0.10	+0.10 -0.00	+0.10 -0.10	+0.10 -0.10	+0.05 -0.05	4000pcs

Notice:

- A. 10 Sprocket hole pitch cumulative tolerance is 0.2mm.
- B. Carrier camber shall be not more than 1mm per 100mm through a length of 250mm.
- C. All dimensions meet EIA-418-B requirements.
- D. A0 & B0 measured as indicated.
- E. K0 measured from a place on the inside bottom of the pocket to top surface of carrier.
- F. Material: PE 100
- G. Thickness: 0.20±0.05mm
- H. 4000 units (maximum) / T&R



Symbol	Dimensions(mm)
W	9.0±0.4
A	180±0.3
N	60±0.3
T	1.4±0.2
E	3±0.5
D	25±0.8



## Yantel Corporation

Add: No.308-322, 3F, Building 1, Jchuang Jingu Innovation Park, Wenyuan Road 35, Xili Street, Nanshan, Shenzhen, China  
Tel: 86-755-8355-1886 Fax: 86-755-8355-2533

Rev A1.2

For detailed performance specs & shopping online see Yantel web site : [www.yantel-corp.com](http://www.yantel-corp.com)