

Fixed Attenuator

- ◆ DC to 6 GHz
- ◆ 30dB
- ◆ 5 Watt
- ◆ N Type Connectors

Features

- High attenuation accuracy
- Small VSWR
- Ceramic chip
- Low cost-high performance

Specifications

Frequency Range	DC to 6 GHz
Attenuation	30 dB
Attenuation Accuracy (Max.)	±2.0 dB over DC – 6 GHz

Nominal Impedance	50 Ohm
Average Power	5 Watt
Operating Temperature	-55 °C to +125°C
Storage Temperature	-55 °C to +125°C

Model No. Description

FATXXXXXX

- X- power handling: 2W or 5W.
- X- connector type: SMA, N type or SMB connector.
- XX- attenuation: **dB.
- XX- 06 represents type number

FREQ. RANGE (GHz)	Typical VSWR(:1)	Maximum VSWR(:1)
DC to 3	1.15	
3 to 4	1.20	
4 to 6	1.25	
DC to 6		1.30

Material & Plating

Parts	Material	Plating(Micro-inch)
Body & Nut	Brass	Ternary alloy
Contact (female & male)	QSn6.5-0.1	Gold 30
Insulator	Teflon	

Characteristic

For example the testing curves of FAT0630N5

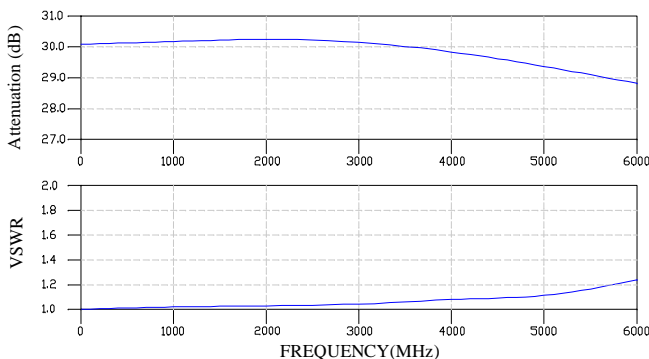

Package Outlines

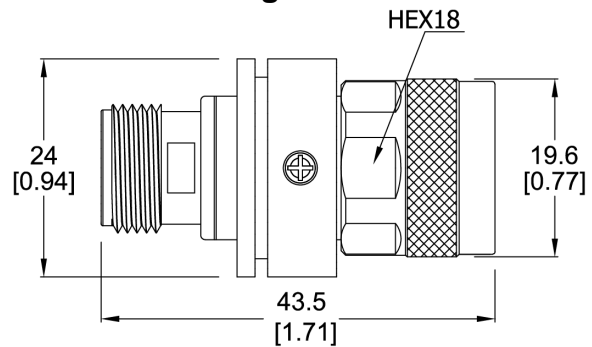

Package type: N

Note: all dimensions shown in mm & inch

Yantel Corporation

Add: 3F, Building 3, Southern District 2 of ZhongGuan Honghualing Industrial Park, Xili, Nanshan, Shenzhen, China
Tel: 86-755-8355-1886 Fax: 86-755-8355-2533

For detailed performance specs & shopping online see Yantel web site : www.yantel-corp.com

Note:**Average power at 25°C ambient, derate linearly to 0.5W at 125°C**