

Data Sheet

DC4000U10-120

Directional Coupler

700 MHz-4.0 GHz



Features

- Small Size (2×2mm)
- Very Low Loss
- Excellent directivity
- Broad frequency coverage
- High Isolation
- Low VSWR
- Good Repeatability
- Tape & Reel
- Power handling:4 watts

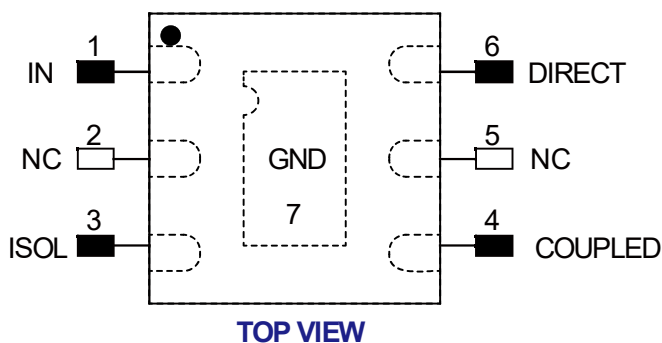
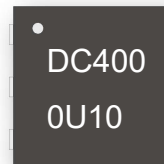
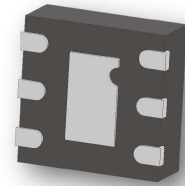

Applications

- Phase shifter / Attenuator
- Balanced amplifier / LNA configurations
- Modulators
- Mixers
- Power combining /dividing

Notes:

1. This part has passed through 100% RF test.
2. Suggest to add Capacitors of DC Blocker between Pins (with black color) and external circuit to prevent DC signal entry to guarantee parts normal work.
3. Suggest to add a TVS Diode in parallel between Electrode (with black color) and Capacitor of DC Blocker to provide ESD protection for the product. TVS Diode use ON Semiconductor's ESD9101 is recommended.

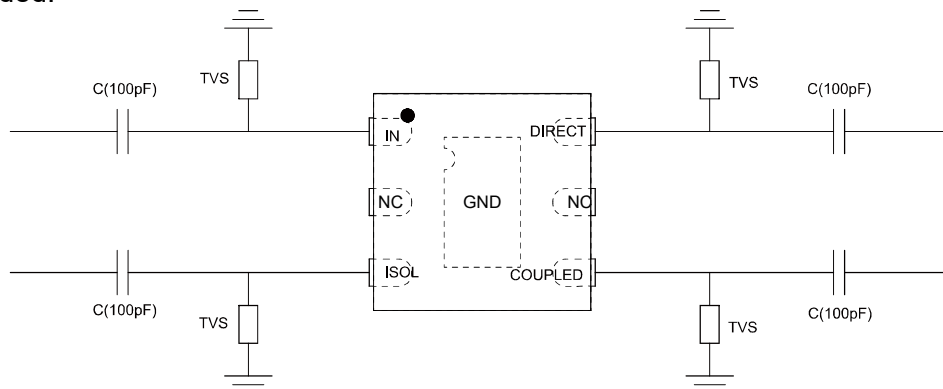

ESD Rating

Human Body Model (HBM): $\leq 650V$ in accordance with ANSI/ESD STM 5.1 - 2001

Machine Model (MM): $\leq 50V$ in accordance with ANSI/ESD STM 5.2 - 1999

Yantel Corporation

Add: 3F, Building 3, Southern District 2 of Zhongguan Honghualing Industrial Park, Xili, Nanshan, Shenzhen, China

Tel: 86-755-8355-1886 Fax: 86-755-8355-2533

Data Sheet

DC4000U10-120

Directional Coupler

700 MHz-4.0 GHz



Electrical Specifications at 25° C

Part No.	Freq. Range (MHz) FL~FU	Power (W)	Size LxW (mm)	Coupling (dB)	Insertion loss (dB)	VSWR(:1)	Directivity (dB)
DC4000U10-120	700~850	4	2X2	26.2	0.21	1.07	20.1
	850~960			24.3	0.21	1.07	19.9
	960~1400			21.1	0.27	1.09	19.1
	1400~1700			19.6	0.31	1.09	19
	1700~2000			18.4	0.35	1.09	19
	2000~2700			15.3	0.46	1.07	19
	2700~4000			12.3	0.85	1.43	13.8

Typical Performance (-40°C, 25°C, 85°C: 700-4000 MHz)

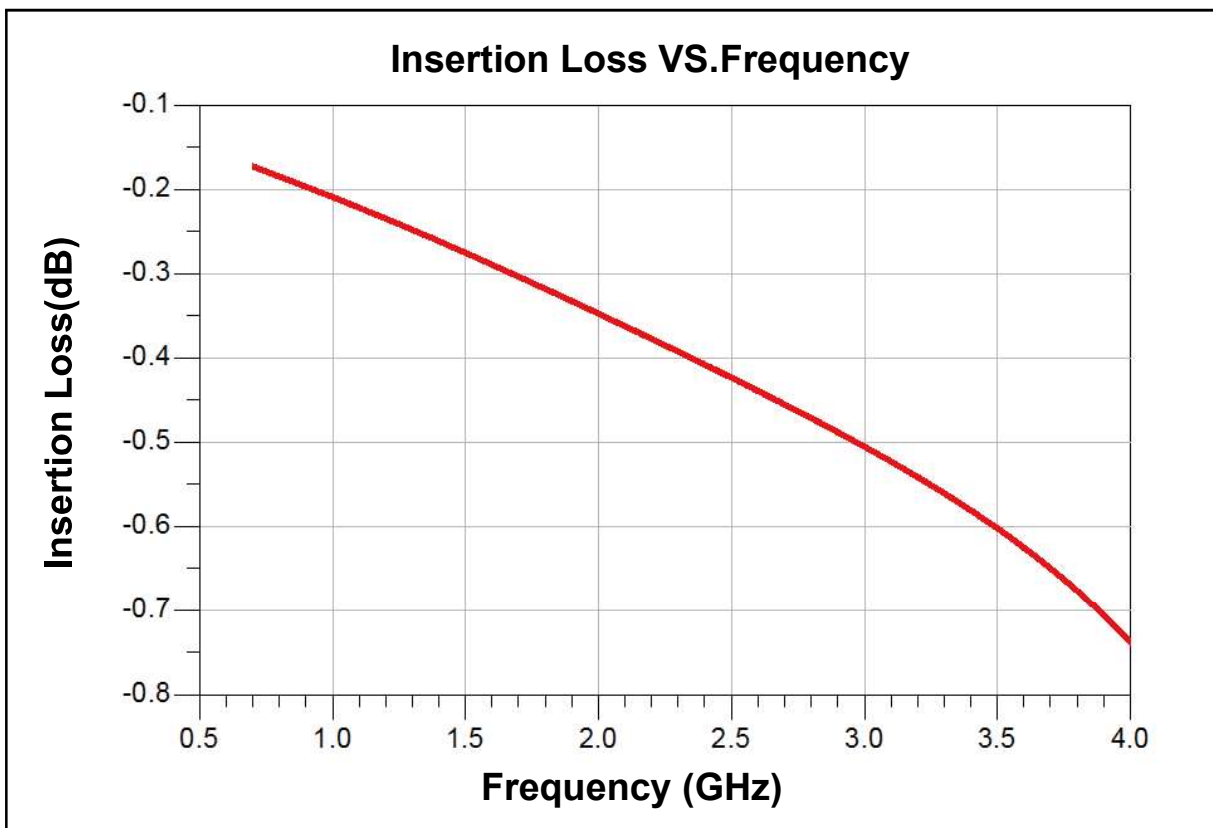

Yantel Corporation

Add: 3F, Building 3, Southern District 2 of Zhongguan Honghualing Industrial Park, Xili, Nanshan, Shenzhen, China
 Tel: 86-755-8355-1886 Fax: 86-755-8355-2533

Data Sheet

DC4000U10-120

Directional Coupler

700 MHz-4.0 GHz

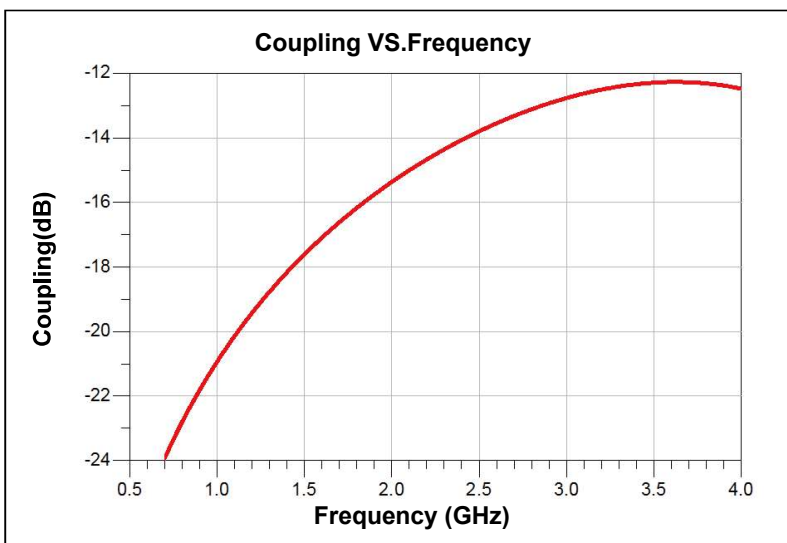
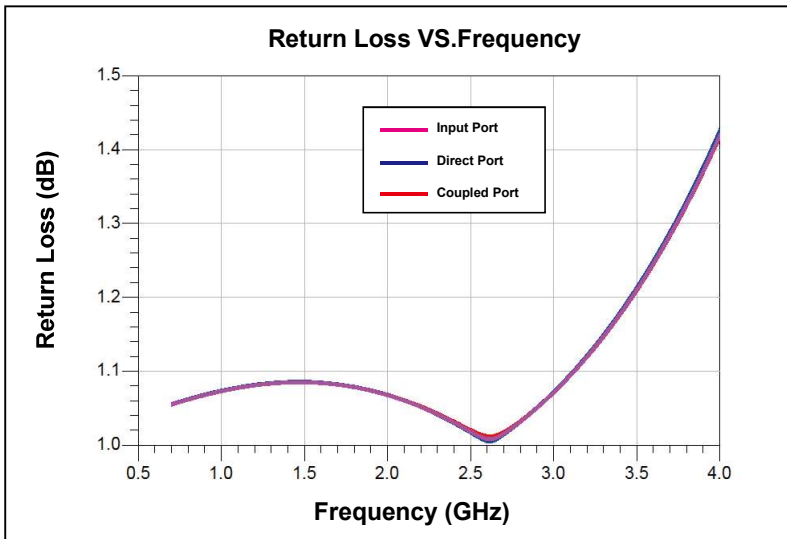
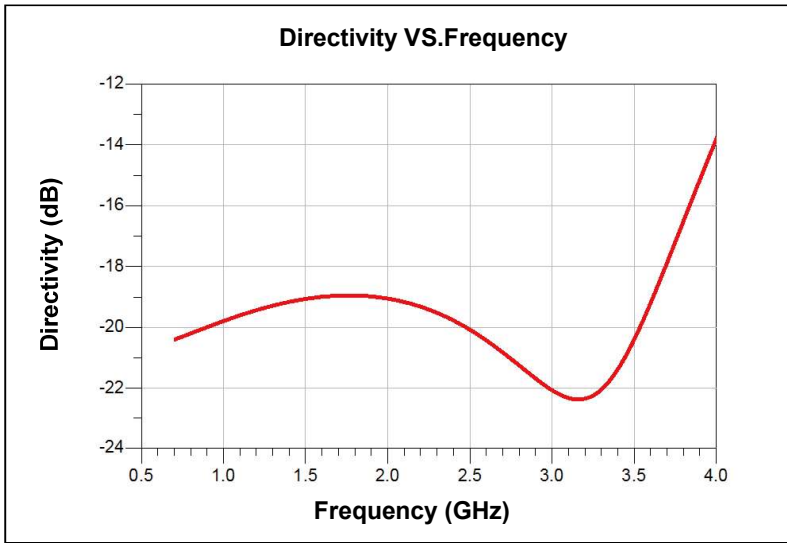

Yantel Corporation

Add: 3F, Building 3, Southern District 2 of Zhongguan Honghualing Industrial Park, Xili, Nanshan, Shenzhen, China
Tel: 86-755-8355-1886 Fax: 86-755-8355-2533

Data Sheet

DC4000U10-120

Directional Coupler

700 MHz-4.0 GHz



Outline Drawing

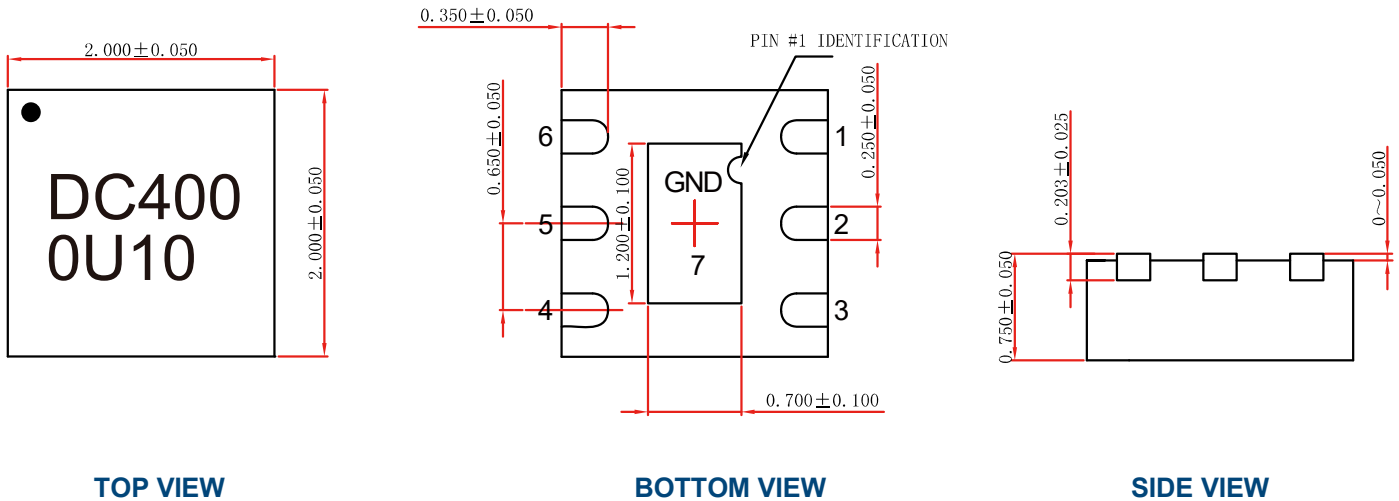

Land Pattern

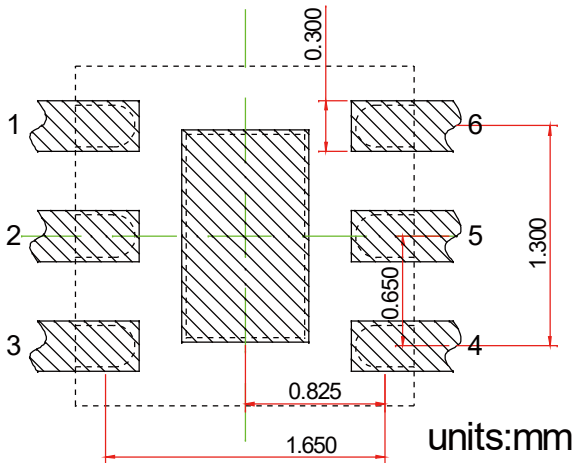

Pin Out

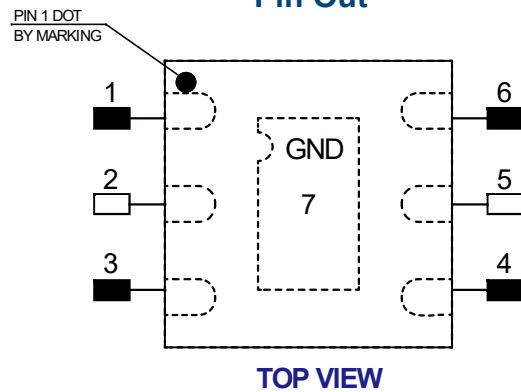

Notes:

1. Require to add Capacitors of DC Blocker between Pins (with black color) and external circuit to prevent DC signal entry to guarantee parts normal work.
2. This part has passed through 100% RF test.

Recommended Land Pattern Top View

Notes: All dimensions show in millimeters

Pin #	Connection
1	IN
2	NC
3	ISOL
4	COUPLED
5	NC
6	DIRECT
7	GND

Yantel Corporation

Add: 3F, Building 3, Southern District 2 of Zhongguan Honghualing Industrial Park, Xili, Nanshan, Shenzhen, China
Tel: 86-755-8355-1886 Fax: 86-755-8355-2533