

Data Sheet

DC420IC21Q

Directional Coupler

4 GHz-20 GHz



Features

- Very Low Loss
- Wideband, 4 to 20 GHz
- Excellent coupling flatness 21 ± 2 dB typ.
- Highly repeatable performance (GaAs based design)
- Power handling :0.89 watts

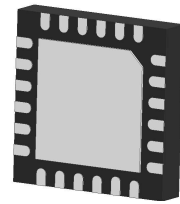

Applications

- Satellite communications
- Wireless infrastructure
- Test and measurements

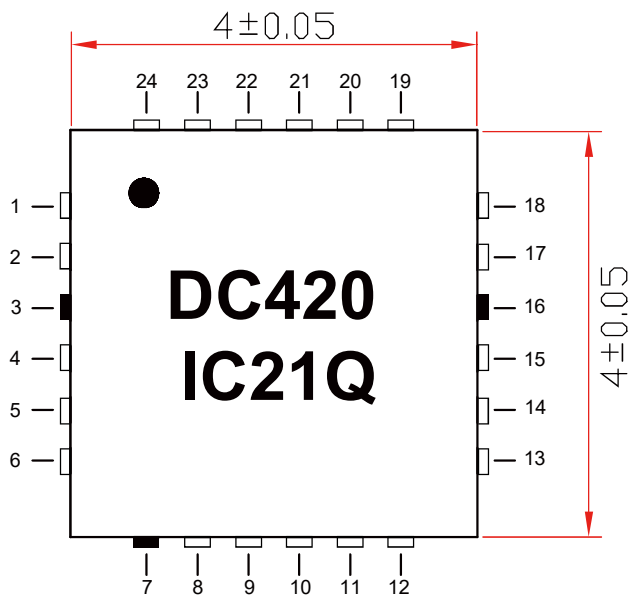

TOP VIEW

Notes:

- 1.Require to add Capacitors of DC Blocker between Pins(with black color) and external circuit to prevent DC signal entry to guranteeparts normal work.
- 2.This part has passed through 100% RF test.

Yantel Corporation

Add: No.308-322, 3F, Building 1, Juchuang Jingu Innovation Park, Wenyuan Road 35, Xili Street, Nanshan, Shenzhen, China
Tel: 86-755-8355-1886 Fax: 86-755-8355-2533

Data Sheet

DC420IC21Q

Directional Coupler

4 GHz-20 GHz



Electrical Specifications at 25°C

Parameter	Frequency (MHz)	Min.	Typ.	Max.	Unit
Frequency Range		4000		20000	MHz
Mainline Loss	4000 - 8000		0.4		dB
	8000 - 10000		0.7		
	10000 - 15000		0.8		
	15000 - 20000		0.9		
Nominal Coupling	4000 - 8000		21		dB
	8000 - 10000		21		
	10000 - 15000		21		
	15000 - 20000		22		
Coupling Flatness(±)	4000 - 20000		2.0		dB
Directivity	4000 - 8000		21		dB
	8000 - 10000		19		
	10000 - 15000		16		
	15000 - 20000		14		
Return Loss (Input)	4000 - 8000		26		dB
	8000 - 10000		16		
	10000 - 15000		17		
	15000 - 20000		21		
Return Loss (Output)	4000 - 8000		26		dB
	8000 - 10000		16		
	10000 - 15000		17		
	15000 - 20000		21		
Return Loss (Coupled)	4000 - 8000		19		dB
	8000 - 10000		16		
	10000 - 15000		15		
	15000 - 20000		21		

Yantel Corporation

Add: No.308-322, 3F, Building 1, Juchuang Jingu Innovation Park, Wenyuan Road 35, Xili Street, Nanshan, Shenzhen, China
 Tel: 86-755-8355-1886 Fax: 86-755-8355-2533

Data Sheet

DC420IC21Q

Directional Coupler

4 GHz-20 GHz



Typical Performance (-55°C, 25°C, 95°C, 125°C: 4000-20000 MHz)

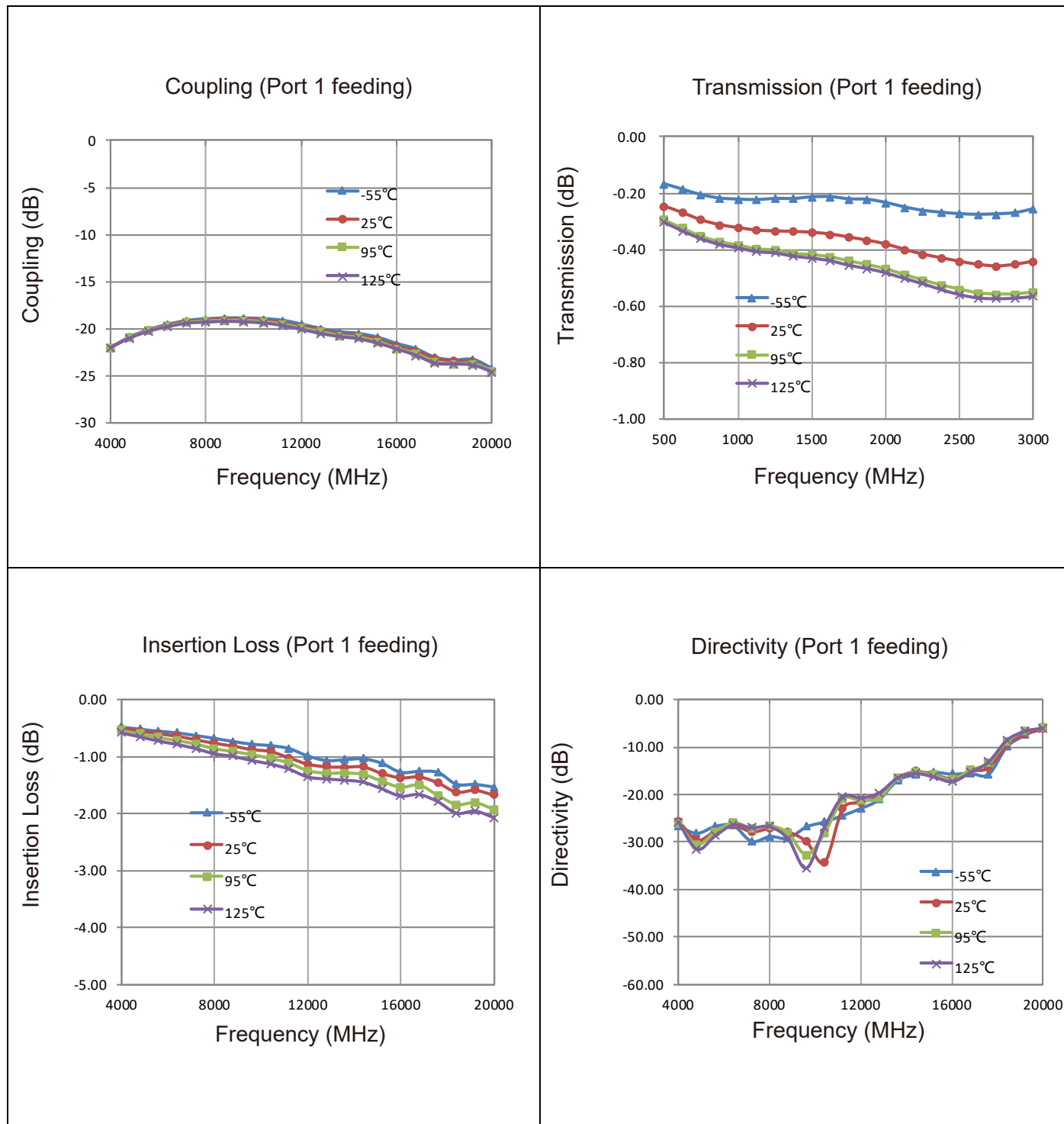

Yantel Corporation

Add: No.308-322, 3F, Building 1, Juchuang Jingu Innovation Park, Wenyuan Road 35, Xili Street, Nanshan, Shenzhen, China
 Tel: 86-755-8355-1886 Fax: 86-755-8355-2533

Rev A0

For detailed performance specs & shopping online see Yantel web site : www.yantel-corp.com

Data Sheet

DC420IC21Q

Directional Coupler

4 GHz-20 GHz



Typical Performance (-55°C, 25°C, 95°C, 125°C: 4000-20000 MHz)

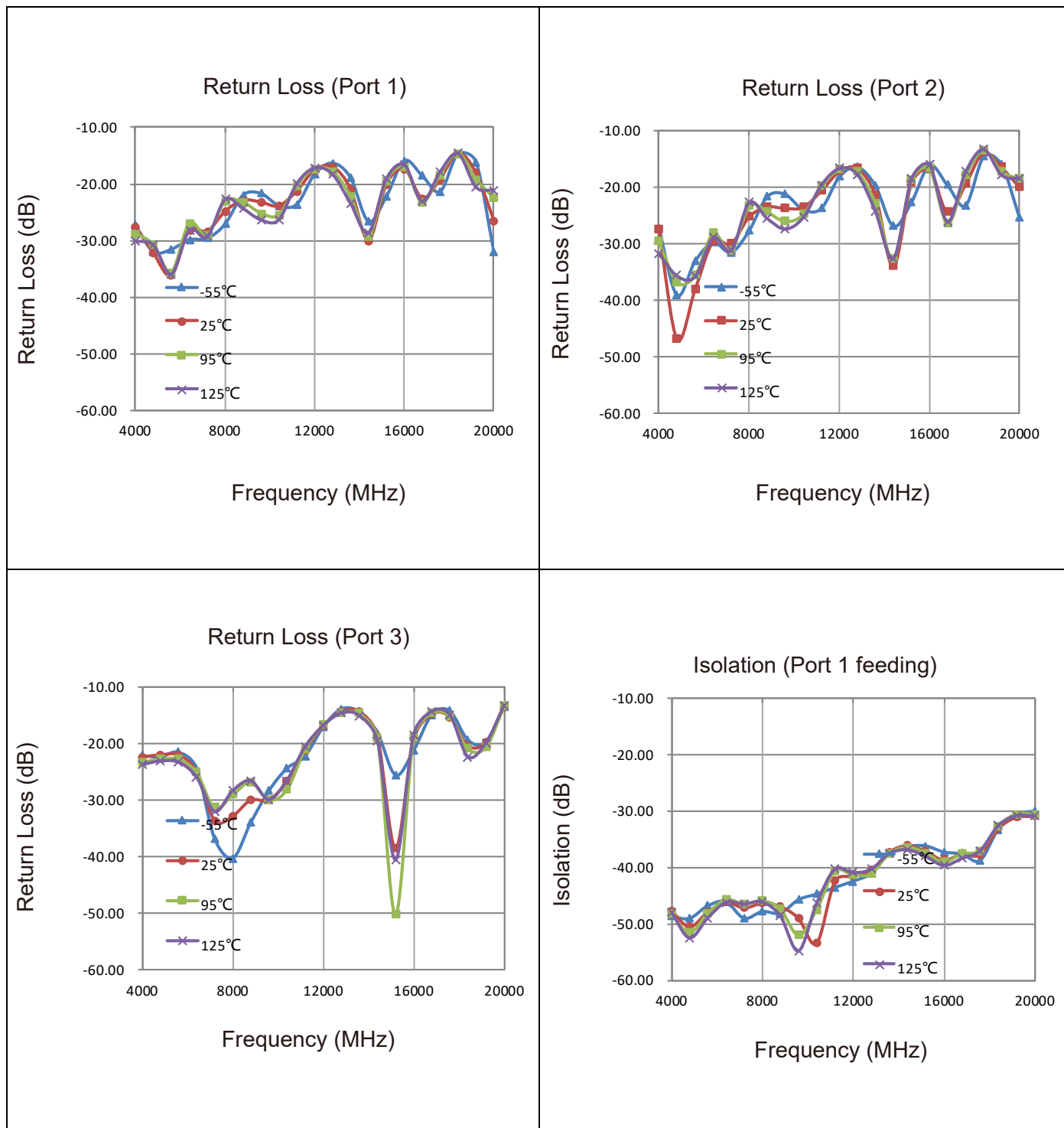

Yantel Corporation

Add: No.308-322, 3F, Building 1, Juchuang Jingu Innovation Park, Wenyuan Road 35, Xili Street, Nanshan, Shenzhen, China
 Tel: 86-755-8355-1886 Fax: 86-755-8355-2533

Rev A0

For detailed performance specs & shopping online see Yantel web site : www.yantel-corp.com

Data Sheet

DC420IC21Q

Directional Coupler

4 GHz-20 GHz



Outline Drawing units:mm

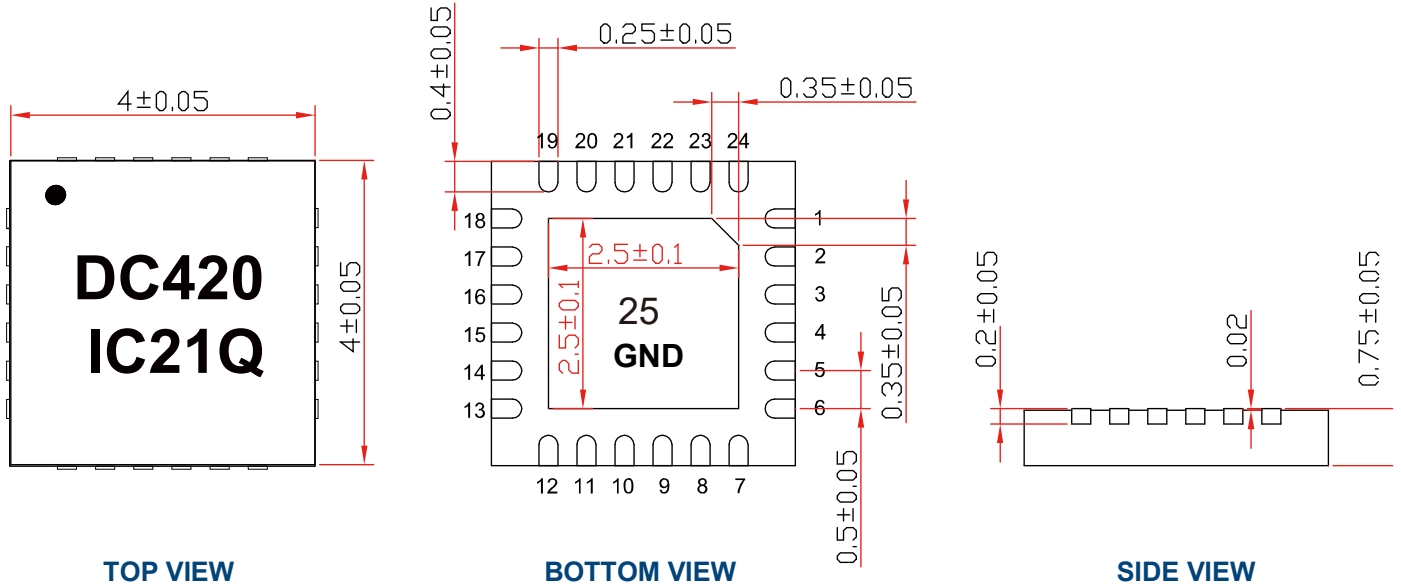

Land Pattern

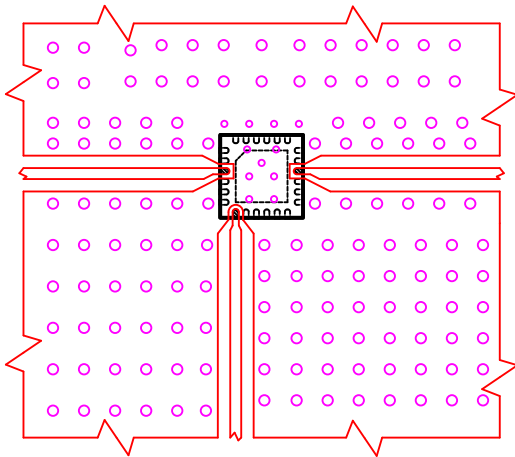

NOTE:

1. 50Ω line width is shown above designing from RO4350B dielectric thickness 0.254mm; copper 1/2 OZ
2. Bottom side of the PCB is continuous ground plane.
3. All dimensions shown in mm.

Pin Out

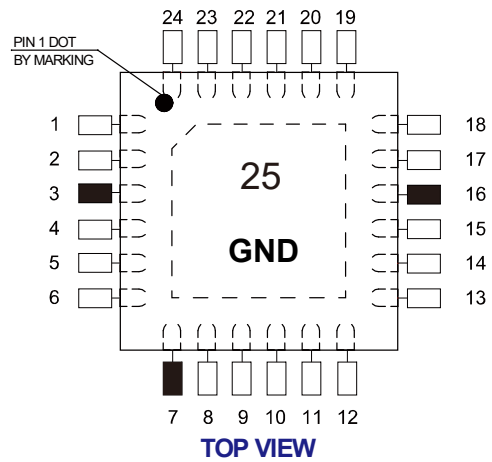

Notes:

1. Require to add Capacitors of DC Blocker between Pins(with black color) and external circuit to prevent DC signal entry to guarantee parts normal work.
2. This part has passed through 100% RF test.

Function	Pad Number		
INPUT	3	7	16
COUPLED	7	3	
OUTPUT	16		3
ISO		16	7
GROUND	Paddle 25		
NC (GROUND EXTERNALLY)	1,2,4,5,6,8-15,17-24		

Yantel Corporation

Add: No.308-322, 3F, Building 1, Juchuang Jingu Innovation Park, Wenyuan Road 35, Xili Street, Nanshan, Shenzhen, China
Tel: 86-755-8355-1886 Fax: 86-755-8355-2533