

General Description

CVD Diamond Chip Attenuators offer extremely high power ratings and smallest size watt-per-watt of any other attenuator configuration on the planet. These attenuators may be used in applications from DC to 26.5 GHz and are ideal for military and space applications because of their high power capability, broad frequency response and small, light-weight size. These attenuators are processed using all thin film construction and have pure thin film gold terminals that are both wire bondable and solderable. They are ideal for peak power applications. High reliability tested versions per MIL-PRF-55342 are also available. Select from tape and reel or waffle packaging. These products are S-level approved. They also meet NASA out-gassing requirements for space applications.

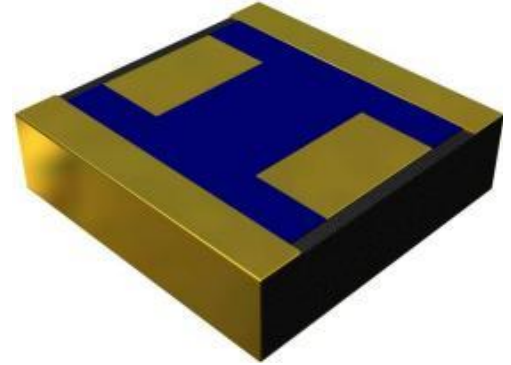

Features

- DC – 26.5 GHz
- CVD Diamond Substrate
- Small Size
- Highest Thermal Performance
- Excellent Peak Power Capability
- Self Passivated Tantalum Nitride Film
- Unaffected By Moisture
- Pure Gold Input/Output Pads
- Wire Bondable Or Solderable
- Meets NASA Out-Gassing Requirements

Applications

- Stabilize Amplifiers
- Improve VSWR Between Stages
- Balance Channels
- Protect Inputs From Overload
- Set Amplification Gain/Power
- Isolate Oscillators
- Isolate Couplers
- Sample Output Power
- Set PST Power Level
- Ideal For Space And Military

Specifications

Nominal Impedance:	50 Ω
Frequency Range:	DC – 26.5 GHz
Power Rating:	20 Watts
Operating Temperature:	-55 °C To +150 °C
Attenuation Value:	See Table Sheet 3
Attenuation Accuracy:	See Table Sheet 3
VSWR:	See Table Sheet 3
Part Identifier:	AD0505 _{XX} (XX=dB)

Yantel Corporation

Add: No.308-322,3F,Building 1,Juchuang Jingu Innovation Park,Wenyuan Road 35,Xili Street,Nanshan,Shenzhen,China
Tel: 86-755-8355-1886 Fax: 86-755-8355-2533

For detailed performance specs & shopping online see Yantel web site : www.yantel-corp.com

Mechanical

Substrate:	CVD Diamond
Resistive Element:	Tantalum Nitride
Termination:	Gold Plated Nickel
Construction:	Thin Film

Power Rating And Derating

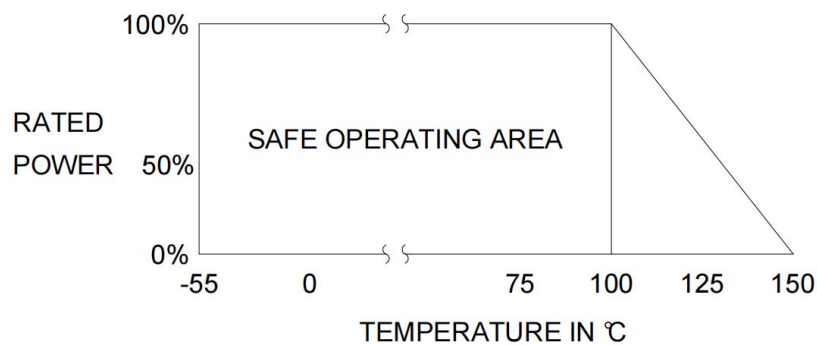

Mechanical Outline

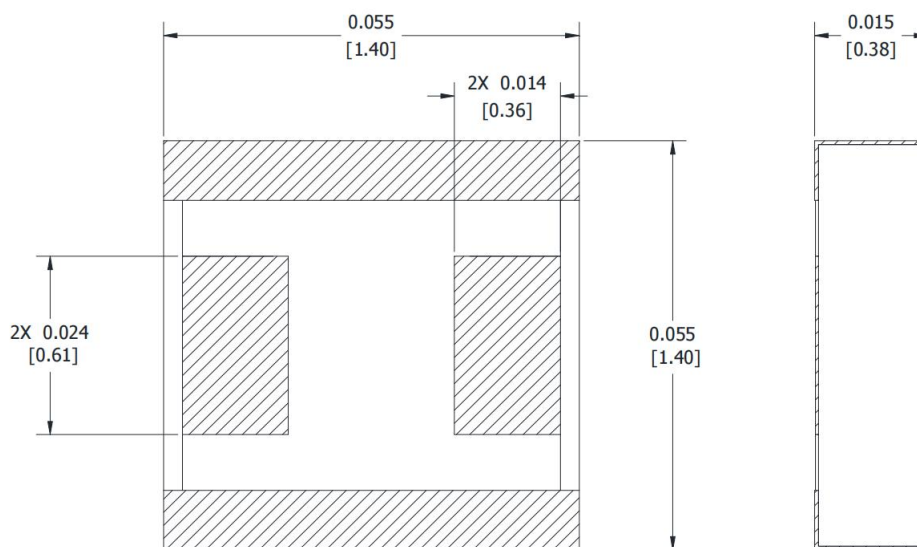

Units =inches[mm]

Yantel Corporation

Add: No.308-322,3F,Building 1,Juchuang Jingu Innovation Park,Wenyuan Road 35,Xili Street,Nanshan,Shenzhen,China
Tel: 86-755-8355-1886 Fax: 86-755-8355-2533

For detailed performance specs & shopping online see Yantel web site : www.yantel-corp.com

Attenuation Accuracy (dB)				
dB VALUE	DC – 8 GHz	8 -12.4 GHz	12.4 – 18 GHz	18 – 26.5 GHz
6	± 0.25	± 0.30	± 0.50	± 0.75

VSWR (MAX)				
dB VALUE	DC – 8 GHz	8 -12.4 GHz	12.4 – 18 GHz	18 – 26.5 GHz
6	1.25	1.3	1.4	1.5

Yantel Corporation

Add: No.308-322,3F,Building 1,Juchuang Jingu Innovation Park,Wenyuan Road 35,Xili Street,Nanshan,Shenzhen,China

Tel: 86-755-8355-1886 Fax: 86-755-8355-2533

 For detailed performance specs & shopping online see Yantel web site : www.yantel-corp.com