

DESCRIPTION

Yantel introduces its new high frequency, wide band surface mountable catalog direction couplers. These couplers incorporate Yantel's high dielectric ceramic materials which provide small size and minimal performance variation over temperature. They are available in symmetrical and Asymmetrical versions.

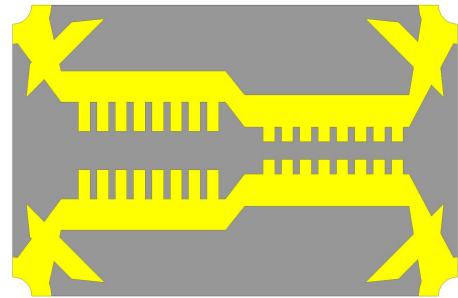

FEATURES

- Small Size
- Fully Shielded Component
- Solder Surface Mount Package
- Moisture Sensitivity Level: MSL1
- Frequency Stable over Temperature
- Operating & Storage Temp: -55°C to +125°C
- Characteristic Impedance: 50Ω

Electrical Specifications

Parameter	Specification
Frequency Range	6~18GHz
Passband Insertion Loss*	≤1dB
Passband Return Loss	≥18dB
Coupling	20-21.5dB
Directivity	≥10dB
Input Power	TBD
Characteristic Impedance	50 Ω
Package Size	0.18 x 0.11 x 0.015 in 4.572 x 2.794 x 0.381mm

*Electrical specifications based on typical mounted performance at room temperature. Insertion loss shall vary ±0.5dB over temperature.

Yantel Corporation

Add: No.308-322,3F,Building 1,Juchuang Jingu Innovation Park,Wenyuan Road 35,Xili Street,Nanshan,Shenzhen,China

Tel: 86-755-8355-1886 Fax: 86-755-8355-2533

For detailed performance specs & shopping online see Yantel web site : www.yantel-corp.com

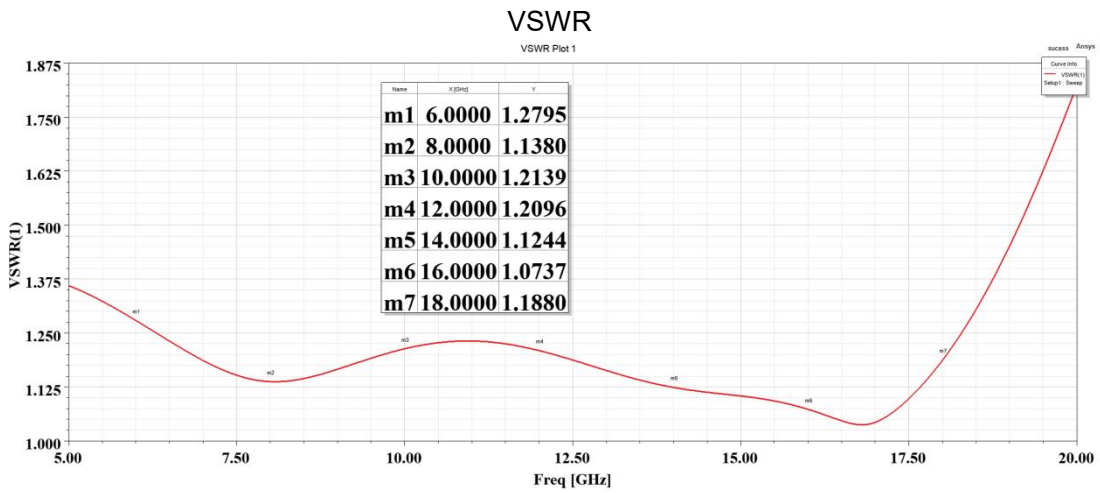
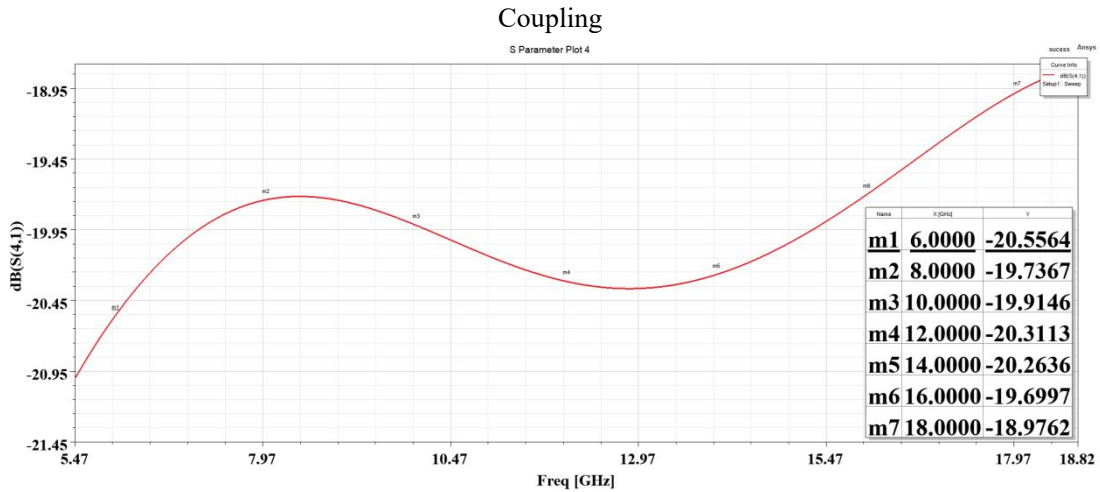
Typical Measured Performance

Yantel Corporation

Add: No.308-322,3F,Building 1,Juchuang Jingu Innovation Park,Wenyuan Road 35,Xili Street,Nanshan,Shenzhen,China

Tel: 86-755-8355-1886 Fax: 86-755-8355-2533

 For detailed performance specs & shopping online see Yantel web site : www.yantel-corp.com

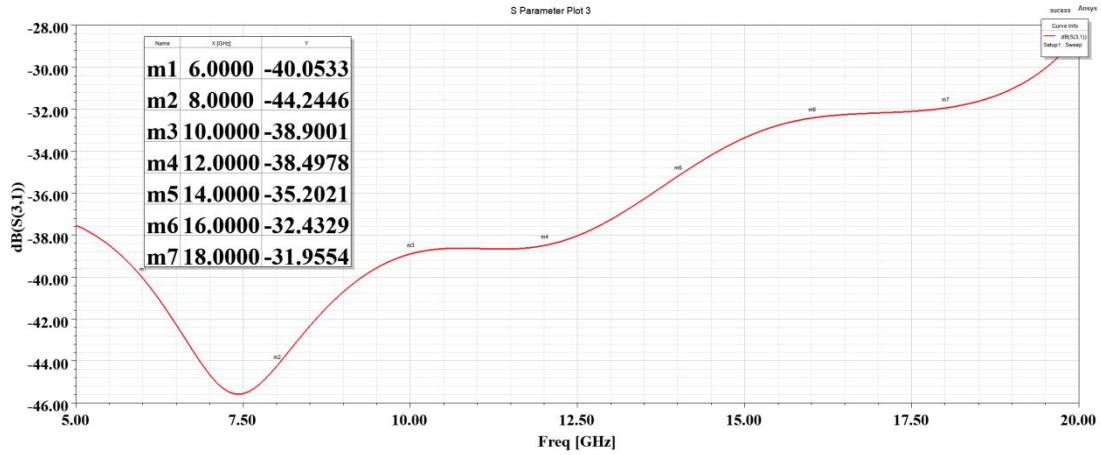
Isolation



Insertion Loss

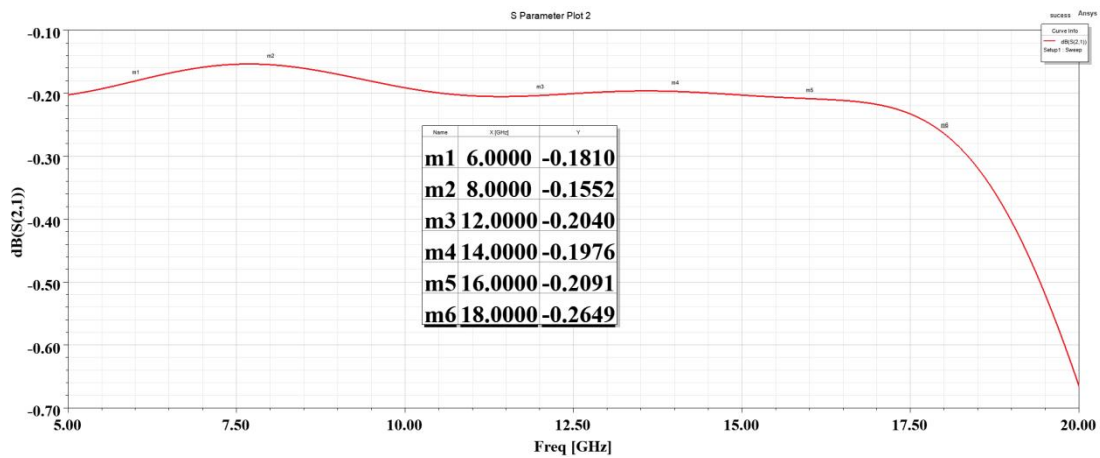

Yantel Corporation

Add: No.308-322,3F,Building 1,Juchuang Jingu Innovation Park,Wenyuan Road 35,Xili Street,Nanshan,Shenzhen,China

Tel: 86-755-8355-1886 Fax: 86-755-8355-2533

For detailed performance specs & shopping online see Yantel web site : www.yantel-corp.com

Physical Dimensions

Units = mils

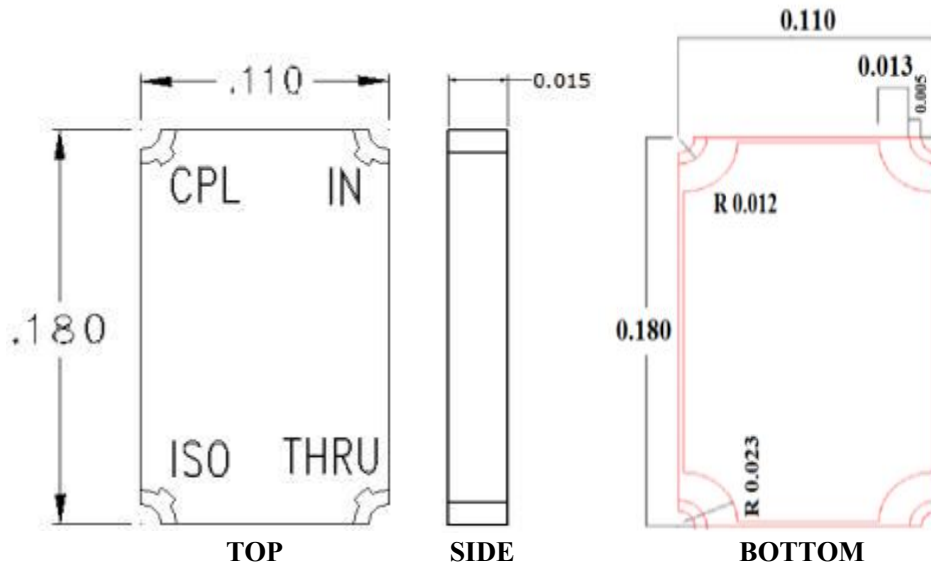
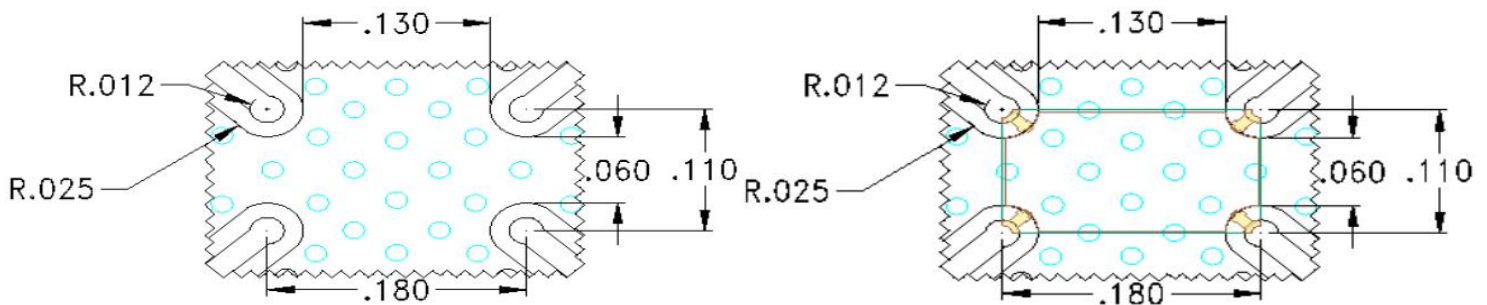
Recommended PCB Layout

- 50Ω trace dimensions are application specific.
- 50Ω trace dimensions are designed for 10 mils R04350B Roger Board.
- Ensure adequate grounding beneath the part.
- Trace feed locations can be horizontal, vertical, or angled.

Yantel Corporation

Add: No.308-322,3F,Building 1,Juchuang Jingu Innovation Park,Wenyuan Road 35,Xili Street,Nanshan,Shenzhen,China

Tel: 86-755-8355-1886 Fax: 86-755-8355-2533

 For detailed performance specs & shopping online see Yantel web site : www.yantel-corp.com